

Tavoli scrivania L 180 con mobile di servizio P 66 (Dx o Sx)/Desks W 180 with service unit D 66 (R or L)

L = L1 - L2 - L3 P 180 x H 75    L = L1 - L2 - L3 P 180 x H 74    L = L1 - L2 - L3 P 180 x H 75

902.TM.6...18\_ Sx/L - Dx/R    902.TV.6...18\_ Sx/L - Dx/R    902.TM.6...18\_ Sx/L - Dx/R

902.PM.6...18\_ Sx/L - Dx/R    902.PV.6...18\_ Sx/L - Dx/R    902.PM.6...18\_ Sx/L - Dx/R

Schema delle 3 posizioni di montaggio/Scheme of 3 assembling solutions

Soluzione base/Suggested solution

Tavoli scrivania L 200 con mobile di servizio P 66 (Dx o Sx)/Desks W 200 with service unit D 66 (R or L)

L = L4 - L5 - L6 P 180 x H 75    L = L4 - L5 - L6 P 180 x H 74    L = L4 - L5 - L6 P 180 x H 75

902.TM.6...20\_ Sx/L - Dx/R    902.TV.6...20\_ Sx/L - Dx/R    902.TM.6...20\_ Sx/L - Dx/R

902.PM.6...20\_ Sx/L - Dx/R    902.PV.6...20\_ Sx/L - Dx/R    902.PM.6...20\_ Sx/L - Dx/R

Schema delle 3 posizioni di montaggio/Scheme of 3 assembling solutions

Soluzione base/Suggested solution

Tavoli scrivania L 180 con mobile di servizio P 92,5 (Dx o Sx)/Desks W 180 with service unit D 92,5 (R or L)

L = L7 - L8 - L9 P 180 x H 75    L = L7 - L8 - L9 P 180 x H 74    L = L7 - L8 - L9 P 180 x H 75

902.TM.9...18\_ Sx/L - Dx/R    902.TV.9...18\_ Sx/L - Dx/R    902.TM.9...18\_ Sx/L - Dx/R

902.PM.9...18\_ Sx/L - Dx/R    902.PV.9...18\_ Sx/L - Dx/R    902.PM.9...18\_ Sx/L - Dx/R

Schema delle 3 posizioni di montaggio/Scheme of 3 assembling solutions

Soluzione base/Suggested solution

Tavoli scrivania L 200 con mobile di servizio P 92,5 (Dx o Sx)/Desks W 200 with service unit D 92,5 (R or L)

L = L10 - L11 - L12 P 180 x H 75    L = L10 - L11 - L12 P 180 x H 74    L = L10 - L11 - L12 P 180 x H 75

902.TM.9...20\_ Sx/L - Dx/R    902.TV.9...20\_ Sx/L - Dx/R    902.TM.9...20\_ Sx/L - Dx/R

902.PM.9...20\_ Sx/L - Dx/R    902.PV.9...20\_ Sx/L - Dx/R    902.PM.9...20\_ Sx/L - Dx/R

Schema delle 3 posizioni di montaggio/Scheme of 3 assembling solutions

Soluzione base/Suggested solution

Note:

1 Le finiture impiallacciato, gres e cuoio non sono in pronta consegna. Per la disponibilità contattare l'ufficio commerciale /Veneered, porcelain stoneware and leather finishes are not in prompt delivery. Please contact the commercial department to check availability;

2 I tavoli possono essere montati sui mobili di servizio (destri o sinistri) scegliendo tra 3 diverse posizioni. Per ogni soluzione compositiva è disponibile la dimensione del corrispondente modesty panel (vedi relativa quota indicata con MP) mentre il canale passacavi si ordina secondo la lunghezza del piano di

lavoro utilizzato/The desks can be mounted on service units (right or left hand) in 3 different positions. Find the proper modesty panel to match the chosen composition (see sizes indicated with MP), while the cable channels change according to the size of the worktop;

3 Le dimensioni sono espresse in cm - consultare il listino prezzi per le caratteristiche tecniche, i codici degli articoli e delle finiture/Dimensions are stated in cm - for technical characteristics, article code numbers and finishing see price list;

4 Prodotti non in pronta consegna. Per la disponibilità contattare l'ufficio commerciale/items not in prompt delivery. Please contact the commercial department to check availability;







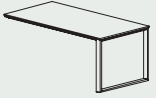
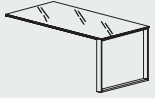
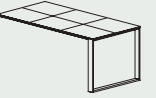
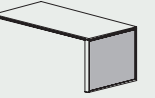
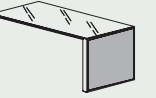
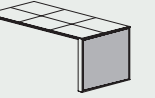
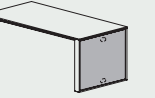
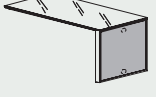
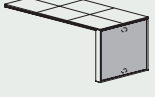





5 Articolo subordinato a commessa minima. Previsto anche nella versione con fori e tappi passacavi (Optional - Vedere listino) /Item tied-up to a minimum quantity production. Also foreseen in a version including holes and out-let lids. (Optional - Refer to price list);

V Vetro/Glass; C Cuoio/Leather; G Gres/Gres.

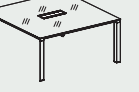



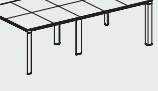

Tavoli per composizioni/Desks for compositions

<p>P 90 x H 75</p> <p>(V)</p>  <p>902.TI.15.18_L 180 902.TI.15.20_L 200</p>	<p>P 90 x H 74</p> <p>(V)</p>  <p>902.TV.11.18_L 180 902.TV.11.20_L 200</p>	<p>P 90 x H 75</p> <p>(C) (■)</p>  <p>902.TI.15.18_L 180 902.TI.15.20_L 200</p>	<p>P 90 x H 75</p>  <p>902.TI.1.18_L 180 902.TI.1.20_L 200</p>	<p>P 90 x H 74</p> <p>(V)</p>  <p>902.TV.1.18_L 180 902.TV.1.20_L 200</p>	<p>P 90 x H 75</p> <p>(C) (■)</p>  <p>902.TI.1.18_L 180 902.TI.1.20_L 200</p>	<p>P 90 x H 75</p>  <p>902.TI.2.18_L 180 902.TI.2.20_L 200</p>
<p>P 90 x H 74</p> <p>(V)</p>  <p>902.TV.2.18_L 180 902.TV.2.20_L 200</p>	<p>P 90 x H 75</p> <p>(C) (■)</p>  <p>902.TI.2.18_L 180 902.TI.2.20_L 200</p>					



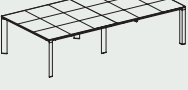
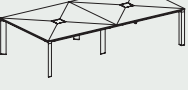
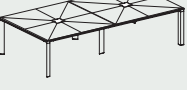

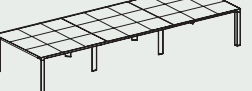
Tavoli riunione/Meeting tables

<p>Ø 100 x H 74,5</p> <p>(V)</p>  <p>902.TV.14.10_</p>	<p>L 100 P 100 x H 75</p>  <p>902.TR.42.10_</p>	<p>L 100 P 100 x H 74,5</p> <p>(V) (∞)</p>  <p>902.TV.77.10_</p>	<p>L 100 P 100 x H 74,5</p> <p>(G) (■)</p>  <p>902.TV.77.10_</p>	<p>L 100 P 100 x H 75</p> <p>(C) (■)</p>  <p>902.TR.42.10_</p>	<p>L 160 P 160 x H 75</p>  <p>902.TR.43.16_</p>	<p>L 160 P 160 x H 74,5</p> <p>(V) (∞)</p>  <p>902.TV.38.16_</p>
<p>L 160 P 160 x H 75</p> <p>(C) (■)</p>  <p>902.TR.43.16_</p>	<p>L 160 P 160 x H 75</p> <p>(E)</p>  <p>902.TR.51.16_</p>	<p>L 160 P 160 x H 75</p> <p>(C) (■) (E)</p>  <p>902.TR.51.16_</p>	<p>L 240 P 120 x H 75</p>  <p>902.TR.41.24_</p>	<p>L 240 P 120 x H 74,5</p> <p>(V)</p>  <p>902.TV.36.24_</p>	<p>L 240 P 120 x H 74,5</p> <p>(G) (■)</p>  <p>902.TV.36.24_</p>	<p>L 240 P 120 x H 75</p> <p>(C) (■)</p>  <p>902.TR.41.24_</p>





Tavoli riunione componibili con gambe centrali rientrate/Modular meeting tables with central recessed legs

<p>L 320 P 160 x H 75</p>  <p>902.TR.32.32_</p>	<p>L 320 P 160 x H 74,5</p> <p>(V) (∞)</p>  <p>902.TV.47.32_</p>	<p>L 320 P 160 x H 75</p> <p>(C) (■)</p>  <p>902.TR.32.32_</p>	<p>L 320 P 160 x H 75</p> <p>(E) (∞)</p>  <p>902.TR.53.32_</p>	<p>L 320 P 160 x H 75</p> <p>(C) (■) (E) (∞)</p>  <p>902.TR.53.32_</p>	<p>L 480 P 160 x H 75</p>  <p>902.TR.32.48_</p>
<p>L 480 P 160 x H 74,5</p> <p>(V) (∞)</p>  <p>902.TV.47.48_</p>	<p>L 480 P 160 x H 75</p> <p>(C) (■)</p>  <p>902.TR.32.48_</p>	<p>L 480 P 160 x H 75</p> <p>(E) (∞)</p>  <p>902.TR.53.48_</p>	<p>L 480 P 160 x H 75</p> <p>(C) (■) (E) (∞)</p>  <p>902.TR.53.48_</p>		

Elementi per tavoli riunioni componibili con gambe centrali rientrate/Modular elements for compound meeting tables with central recessed legs

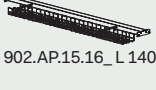
<p>L 160 P 160 x H 75</p>  <p>902.TR.32.16_</p>	<p>L 160 P 160 x H 74,5</p> <p>(V) (∞)</p>  <p>902.TV.47.16_</p>	<p>L 160 P 160 x H 75</p> <p>(C) (■)</p>  <p>902.TR.32.16_</p>	<p>L 160 P 160 x H 75</p> <p>(E) (∞)</p>  <p>902.TR.53.16_</p>	<p>L 160 P 160 x H 75</p> <p>(C) (■) (E) (∞)</p>  <p>902.TR.53.16_</p>
---	---	---	---	---

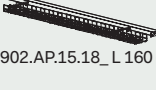
Modesty panel – canalizzazione per tavoli scrivanie su mobili di servizio/Modesty panel – wire management for desks on service units

<p>Per tavoli L 180/For desks W 180</p>  <p>902.AP.15.16_L 140 (L 180)</p>  <p>902.AP.21.18_L 140</p>	<p>902.MP.08.10_L 100 (L1-L7)</p> <p>902.MP.08.12_L 120 (L8)</p> <p>902.MP.08.13_L 130 (L2)</p> <p>902.MP.08.14_L 140 (L3-L9)</p>	<p>902.MP.13.10_L 100 (L1-L7)</p> <p>902.MP.13.12_L 120 (L8)</p> <p>902.MP.13.13_L 130 (L2)</p> <p>902.MP.13.14_L 140 (L3-L9)</p>	<p>Per tavoli L 200/For desks W 200</p>  <p>902.AP.15.18_L 160 (L 200)</p>  <p>902.AP.21.20_L 160</p>	<p>902.MP.09.12_L 120 (L4-L10)</p> <p>902.MP.09.14_L 140 (L11)</p> <p>902.MP.09.15_L 150 (L5)</p> <p>902.MP.09.16_L 160 (L6-L12)</p>	<p>902.MP.14.12_L 120 (L4-L10)</p> <p>902.MP.14.14_L 140 (L11)</p> <p>902.MP.14.15_L 150 (L5)</p> <p>902.MP.14.16_L 160 (L6-L12)</p>
---	---	---	---	--	--

# DV902 Planeta

# Dati tecnici/Technical data

## Modesty panel in leather /Leather modesty panel

## Accessori /Accessories

P 1,8 x H 38 Per tavoli L 180/For desks W 180

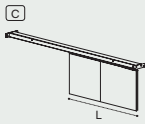

902.MP.08.10\_ L 100 (L1 - L7)  
902.MP.08.12\_ L 120 (L8)  
902.MP.08.13\_ L 130 (L2)

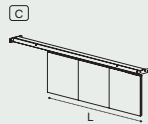

902.MP.08.14\_ L 140 (L3 - L9)

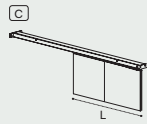

902.MP.09.12\_ L 120 (L4 - L10)

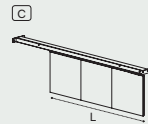

902.MP.09.14\_ L 140 (L11)  
902.MP.09.15\_ L 150 (L5)  
902.MP.09.16\_ L 160 (L6 - L12)

L 90 P 60 x H 2

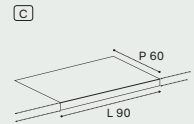

300.AS.01.09

## Canalizzazione per tavoli scrivanie/Wire management for desks

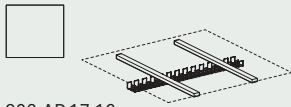

902.AP.17.16\_  
Per:/For: L 160



902.AP.18.16\_  
Per:/For: L 160

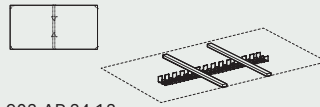

902.AP.24.12\_  
Per:/For: L 240

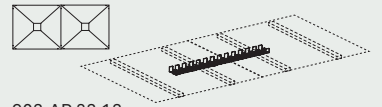

902.AP.32.12\_  
Per:/For: L 320

## Cassettiere/Pedestals

L 42 P 57 x H 55,5

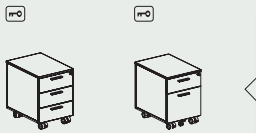

550.CS.10.04\_ 550.CS.20.04\_  
Melaminico/Melamine Melaminico/Melamine

L 32,2 P 54,2 x H 55,6

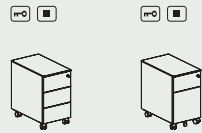

550.CS.1M.03\_ 550.CS.2M.03\_  
Metalliche/Metallic Metalliche/Metallic

L 42,2 P 54,2 x H 55,6

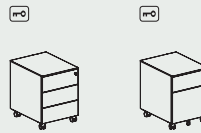

550.CS.1M.04\_ 550.CS.2M.04\_  
Metalliche/Metallic Metalliche/Metallic  
Vaschetta porta cancelleria inclusa  
/Stationery tray included

L 180 P 66 x H 63

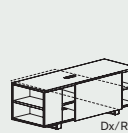

902.MS.6\_.18\_  
Sx/L - Dx/R  
Indipendenti e per integrazione  
/Independent and for integration

L 180 P 92,5 x H 63

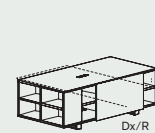

902.MS.9\_.18\_  
Sx/L - Dx/R  
Indipendenti e per integrazione  
/Independent and for integration

L 42 P 55 x H 48

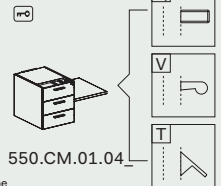

550.CM.01.04\_

Note: La finitura impiallacciato non è in pronta consegna. Per la disponibilità contattare l'ufficio commerciale. Per portacancelleria cassetti, vedi capitolo DV300-Accessori/Veneered finishes is not in prompt delivery. Please contact the commercial department to check availability. For stationary tray, see chapter DV300-Accessories.

## Accessori per canalizzazione - Elettrificazione - Vari/Accessories for wire management - Electrification - Various

(+) (+) (+) (+)

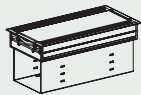

300.AC.26.02 L 24,5  
300.AC.26.03 L 34,5  
300.AC.26.04 L 44,5

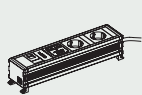

300.AP.S1.02 L 20,5  
300.AP.S1.03 L 30  
300.AP.S1.04 L 42  
Per/For top access 300.AC.26\_

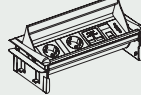

300.AT.A1.02 L 22  
300.AT.A1.03 L 31,5  
300.AT.A1.04 L 43,5

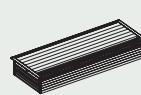

300.AC.36.02 L 32



300.APT2.01 Ø 8



300.APT7.01 Ø 6  
300.APT8.01 Ø 8

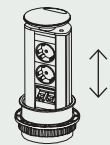

300.APT4.01  
300.APT5.01 - UK (+)  
300.APT6.01 - US (+)

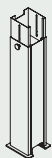

300.AP.V2.15



300.AP.V1.00

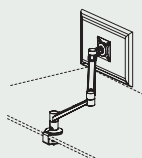

300.AC.04.01  
Braccio porta video mobile su piano  
/Dynamic arm for video support on deskbase

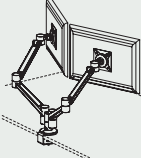

300.AC.04.02  
Doppio braccio porta video mobile  
su piano/2 dynamic arms for video support on deskbase

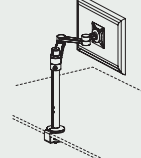

300.AC.03.01  
Braccio porta video statico  
su palo/Dynamic arm for video support on deskbase

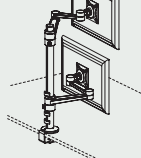

300.AC.03.02  
Doppio braccio porta video statico  
su palo/2 Static arms for video support on pole

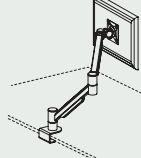

300.AC.02.01  
Braccio porta video mobile su piano  
/Dynamic arm for video support on deskbase

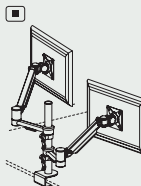

300.AC.02.02  
Doppio braccio porta video mobile  
su piano/2 dynamic arms for video support on deskbase

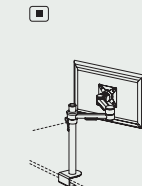

300.AC.01.01  
Braccio porta video statico  
su palo/Static arm for video support on pole

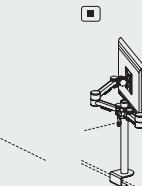

300.AC.01.02  
Doppio braccio porta video statico  
su palo/2 Static arms for video support on pole

### Note:

1 Le finiture impiallacciato e gres non sono in pronta consegna. Per la disponibilità contattare l'ufficio commerciale /Veneered and gres finishes are not in prompt delivery. Please contact the commercial department to check availability;

2 Per la scelta dei contenitori e degli accessori vari, consultare il relativo listino o catalogo/To choose storage units and accessories, please check correspondent price list or catalogue;

3 Le dimensioni sono espresse in cm - consultare il listino prezzi per le caratteristiche tecniche, i codici degli articoli

e delle finiture/Dimensions are stated in cm - for technical characteristics, article code numbers and finishing see price list;

Prodotti non in pronta consegna. Per la disponibilità contattare l'ufficio commerciale/Items not in prompt delivery. Please contact the commercial department to check availability;

Articoli prodotti solo su richiesta/Items produced only on demand;

Fino ad esaurimento/Until exhaustion;

Per eventuali giacenze a magazzino delle precedenti versioni senza top-access, contattare l'ufficio commerciale/To check stock availabilities of table tops without top-access, please contact our commercial department;

Vetro/Glass; Cuoio/Leather; G Gres/Gres;

Con serratura/With lock;

Tavoli scrivania con piani composti /Desks with compound worktops.