

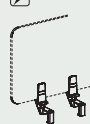

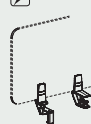



Morsetti e supporti per frontal panels sp. 3 - Sp. 1 - Sp. 0,8/Clamps for frontal panels t. 3 - T. 1 - T. 0,8

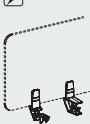

						
<b>300.FP.27.00</b> Per piani/For worktops	<b>300.FP.29.00</b> Per gamba (serie DV801 e DV802) /For leg (series DV801 and DV802)	<b>300.FP.32.00</b> Per piano-gamba (serie DV801 e DV802)/For worktop-leg (series DV801 and DV802)	<b>300.FP.30.00</b> Per gamba (serie DV805) /For leg (serie DV805)	<b>300.FP.31.00</b> Per piano-gamba (serie DV805) /For worktop-leg (serie DV805)	<b>300.FP.28.00</b> Per piani-binari /For worktops-track	<b>300.FP.26.00</b> Per FP 1; Per profilo attrezzabile (serie DV801)/For FP 1; For accessory profile (serie DV801)

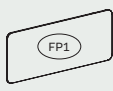
Per frontal panels/For frontal panels FP1 FP08 FPC1 FPC2

Frontal panels sp. 1 - sp. 0,8

<b>P 1 x H 39</b>	<b>P 0,8 x H 39</b>
	
300.FP.06.06 L 64 300.FP.06.07 L 79 300.FP.06.09 L 99 300.FP.06.11 L 119 300.FP.06.13 L 139 300.FP.06.15 L 159 300.FP.06.17 L 179 300.FP.06.19 L 199 Melaminico/Melamine	300.FPV1.06 L 64 300.FPV1.07 L 79 300.FPV1.09 L 99 300.FPV1.11 L 119 300.FPV1.13 L 139 300.FPV1.15 L 159 300.FPV1.17 L 179 300.FPV1.19 L 199 Vetro/Glass

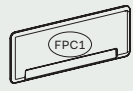
Frontal panel fonoassorbenti sp. 3 /Acoustic frontals panels t. 3

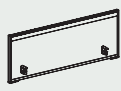
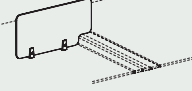

<b>P 3 x H 39</b>	<b>P 3 x H 59</b>
	
300.FP.40.06 L 64 300.FP.40.07 L 79 300.FP.40.09 L 99 300.FP.40.11 L 119 300.FP.40.13 L 139 300.FP.40.15 L 159 300.FP.40.17 L 179 Tessuto/Fabric	300.FP.50.13 L 139 300.FP.50.15 L 159 Tessuto/Fabric

Frontal panels con morsetti e supporti integrati /Frontal panels with clamps

<b>P 4 x H 59</b>	<b>L 77 P 1 x H 39</b>
	
300.FR.07.14 L 140 300.FR.07.16 L 160 Per piani/For worktops	300.FR.19.07 Per piani melaminico /For worktops melamine



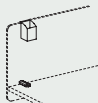
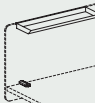
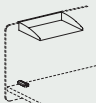

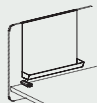















In caso di BENCH, controllare lo spazio disponibile tra una gamba e l'altra /In the case of BENCH, verify the useful gap between a leg and the next one

Accessori per frontal panels in melaminico/Accessories for melamine frontal panels

<b>L 6,5 P 6,5 x H 8,5</b>	<b>L 50 P 17 x H 3</b>	<b>L 31 P 22 x H 5</b>	<b>L 23 P 10 x H 29</b>	<b>L 35 P 6,5 x H 30</b>
				
<b>300.FA.01.01</b>	<b>300.FA.02.05</b>	<b>300.FA.04.03</b>	<b>300.FA.06.02</b>	<b>300.FA.08.03</b>

**Note:** Il posizionamento degli accessori sui frontal panel in vetro prevede l'utilizzo di una guarnizione in PVC trasparente (Optional su richiesta)/Placement of accessories on glass front panel need the use of a transparent PVC gasket (Optional on request)  
 Non utilizzabile su Frontal Panels Colibri  /Not usable for Colibri Frontal Panels

Tavolini caffè/Coffee tables

<b>P 60 x H 42,5</b>	<b>P 60 x H 42,5</b>	<b>P 60 x H 45</b>	<b>P 60 x H 40</b>	<b>Ø 60 x H 45</b>	<b>Ø 60 x H 45</b>	<b>Ø 60 x H 45</b>
						
300.TT.02.06 L 60 300.TT.02.12 L 120	300.TT.03.06 L 60 300.TT.03.12 L 120	300.TV.25.06 L 60 300.TV.25.12 L 120	903.TV.01.06 L 60 903.TV.01.12 L 120	300.TT.04.06 Con gambe metalliche /With metal legs	300.TT.04.06 Con gambe metalliche /With metal legs	300.TT.04.06 Con gambe coniche in legno /With wooden conic legs
<b>Ø 60 x H 45</b>	<b>Ø 60 x H 74</b>	<b>Ø 60 x H 74</b>	<b>Ø 60 x H 74</b>	<b>Ø 60 x H 74</b>	<b>L 100 P 100 x H 45</b>	<b>L 100 P 100 x H 45</b>
						
300.TT.04.06 Con gambe coniche in legno /With wooden conic legs	804.TR.20.06 Con gambe freestanding DV804 /With freestanding legs DV804	804.TR.20.06 Con gambe freestanding DV804 /With freestanding legs DV804	300.TR.20.06 Con gambe coniche in legno /With wooden conic legs	300.TR.20.06 Con gambe coniche in legno /With wooden conic legs	300.TT.05.10 Con gambe metalliche /With metal legs	300.TT.05.10 Con gambe metalliche /With metal legs
<b>L 100 P 100 x H 45</b>	<b>L 100 P 100 x H 45</b>	<b>L 100 P 100 x H 74</b>	<b>L 100 P 100 x H 74</b>	<b>L 100 P 100 x H 74</b>	<b>L 100 P 100 x H 74</b>	<b>Ø 60 x H 46</b>
						
300.TT.05.10 Con gambe coniche in legno /With wooden conic legs	300.TT.05.10 Con gambe coniche in legno /With wooden conic legs	804.TR.31.10 Con gambe freestanding DV804 /With freestanding legs DV804	804.TR.31.10 Con gambe freestanding DV804 /With freestanding legs DV804	300.TR.31.10 Con gambe coniche in legno /With wooden conic legs	300.TR.31.10 Con gambe coniche in legno /With wooden conic legs	300.TT.06.06 Con base in cemento /With cement base

Note:

- 1 Le dimensioni sono espresse in cm - consultare il listino prezzi per le caratteristiche tecniche, i codici degli articoli e delle finiture/Dimensions are stated in cm - for technical characteristics, article code numbers and finishing see price list;
- Prodotti non in pronta consegna. Per la disponibilità contattare l'ufficio commerciale/Items not in prompt delivery. Please contact the commercial department to check availability;
- Fino ad esaurimento/Until exhaustion;
- Prodotti Colibri/Colibri products.
- G Piani in Gres porcellanato/Worktops in Porcelain stoneware;

Colonne e gamboni/Metal columns

H 71,5

L 55 P 55 x H 71,5

L 48 P 48 x H 73

L 5 x P 5



300.AC.17.06 Ø 60



300.AC.51.08



300.AC.18.04



703.GM.01.01 H 71,5  
802.GF.05.01 H 72,2

Tavoli su gamboni regolabili/Tables on adjustable metal column

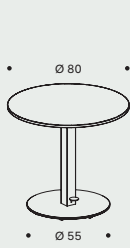

300.TR.60.08\_

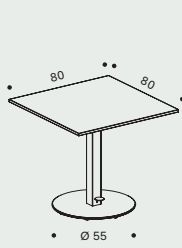

300.TR.61.08\_

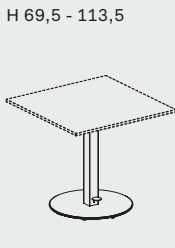

300.TR.62.00\_

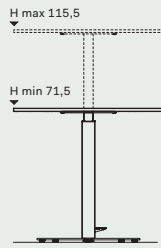

**Note:** Regolazione con sistema pneumatico a pedale. Piano in melaminico sp. 18 mm con bordi perimetrali in ABS/Adjustment with pneumatic pedestal system. Worktops in melamine 18 mm thick with ABS perimetrical edges

Tavoli su ruote con piano ribaltabile/Tables on castors with flip worktop

P 70 - H 74

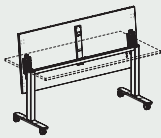

300.TF.01.08 L 80  
300.TF.01.10 L 100  
300.TF.01.12 L 120  
300.TF.01.14 L 140  
300.TF.01.16 L 160  
300.TF.01.18 L 180

P 80 - H 74

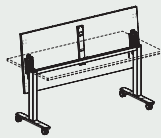

300.TF.02.08 L 80  
300.TF.02.10 L 100  
300.TF.02.12 L 120  
300.TF.02.14 L 140  
300.TF.02.16 L 160  
300.TF.02.18 L 180

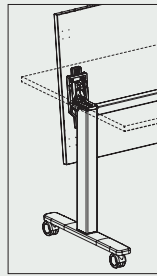

P 1 - H 31



300.MP.10.08 L 46,5  
300.MP.10.10 L 66,5  
300.MP.10.12 L 86,5  
300.MP.10.14 L 106,5  
300.MP.10.16 L 126,5  
300.MP.10.18 L 146,5

Modesty panel per tavolo con piano ribaltabile /Modesty panel for table with flip worktop

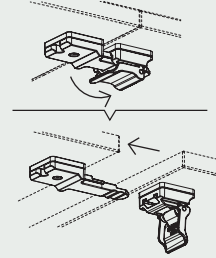

300.KT.04.00  
Ganci per collegare in linea tavoli folding /Hooks to connect folding desks in line

Lampade/Lights

L 200 P 14,5 x H 37



300.AC.50.20  
Da integrare ai tavoli riunione /To be integrated with meeting tables

Mensola con supporti/Wall-shelf with supports

P 30 x H 2,5



300.AC.M1.09 L 90  
300.AC.M1.13 L 130  
300.AC.M1.18 L 180



300.AC.M2.00  
Coppia ovetti reggi-mensola /Pair of egg-shaped wall-shelf support

Divani/Sofas

L 84 P 80 x H 83



300.AC.D1.08

L 144 P 80 x H 83

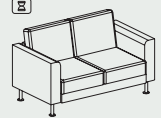

300.AC.D1.14

Bracci porta video/Arms for video support

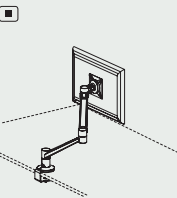

300.AC.04.01  
Braccio porta video mobile su piano /Dynamic arm for video support on deskbase

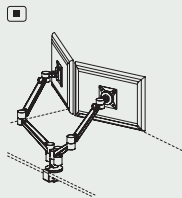

300.AC.04.02  
Doppio braccio porta video mobile su piano /2 dynamic arms for video support on deskbase

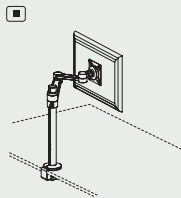

300.AC.03.01  
Braccio porta video statico su palo /Static arm for video support on pole

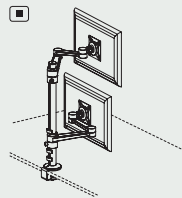

300.AC.03.02  
Doppio braccio porta video statico su palo /2 static arms for video support on pole

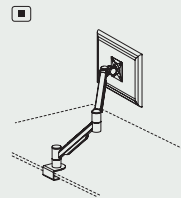

300.AC.02.01  
Braccio porta video mobile su piano /Dynamic arm for video support on deskbase

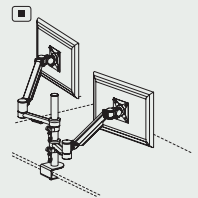

300.AC.02.02  
Doppio braccio porta video mobile su piano /2 dynamic arms for video support on deskbase

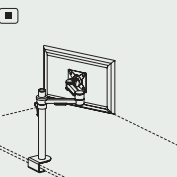

300.AC.01.01  
Braccio porta video statico su palo /Static arm for video support on pole

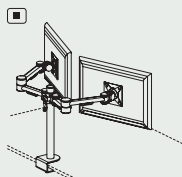

300.AC.01.02  
Doppio braccio porta video statico su palo /2 static arms for video support on pole

300.AP.15.04 L 45 300.AP.15.05 L 45 300.AP.15.07 L 45 300.AP.15.08 L 45 300.AP.15.10 L 45 300.AP.15.11 L 45 300.AP.15.14 L 45 300.AP.15.16 L 45	300.AP.30.02 L 24 300.AP.30.06 L 60 300.AP.30.09 L 90 300.AP.30.11 L 110 300.AP.30.14 L 140 300.AP.30.16 L 160	300.CL.01.40 L 115	300.AP.20.00 L 57	804.CL.02.01 L 10 804.CL.02.04 L 45 804.CL.02.06 L 65 804.CL.02.08 L 85 804.CL.02.11 L 110

300.AP.U1.01 Ø 6 300.AP.U2.02 Ø 8 300.AP.U3.03 Ø 10,2	300.AP.T2.01 Ø 8	300.AP.T7.01 Ø 6 300.AP.T8.01 Ø 8	300.AP.F1.00	300.AP.08.00	300.AP.V1.00	300.AP.31.06	300.AP.V2.15

300.AC.36.02 H 1,8 300.AC.36.03 H 2,5 300.AC.36.04 H 3,8 300.AC.36.05 H 5	300.AC.26.02 L 24,5 300.AC.26.03 L 34,5 300.AC.26.04 L 44,5	300.AC.20.02 L 24,5 300.AC.20.03 L 34,5 300.AC.20.04 L 44,5	300.AC.25.02 L 23,5 300.AC.25.03 L 33,5 300.AC.25.04 L 43,5 Marsupio/Basket	300.AC.56.02 L 23,5 300.AC.56.03 L 33,5 300.AC.56.04 L 43,5 Marsupio Optional con altezza maggiorata/Optional basket with increased height	300.AC.33.02	300.AC.16.02

300.AP.S1.02 300.AP.S2.02 UK 300.AP.S3.02 US Per top access 300.AC.26.02 /For top access 300.AC.26.02	300.AP.S1.03 300.AP.S2.03 UK 300.AP.S3.03 US Per top access 300.AC.26.03 /For top access 300.AC.26.03	300.AP.S1.04 300.AP.S2.04 UK 300.AP.S3.04 US Per top access 300.AC.26.04 /For top access 300.AC.26.04	300.AT.A1.02 300.AT.A2.02 UK 300.AT.A3.02 US	300.AT.A1.03 300.AT.A2.03 UK 300.AT.A3.03 US	300.AT.A1.04 300.AT.A2.04 UK 300.AT.A3.04 US	300.AP.T4.01 300.AP.T5.01 UK 300.AP.T6.01 US

300.AC.75.07	300.AC.15.08	300.AC.14.03 Box multiuso /Storage box	300.AC.06.05	300.AC.07.01

Note:

1 Le dimensioni sono espresse in cm – consultare il listino prezzi per le caratteristiche tecniche, i codici degli articoli e delle finiture/Dimensions are stated in cm – for technical characteristics, article code numbers and finishing see price list;

2 Prodotti non in pronta consegna. Per la disponibilità contattare l'ufficio commerciale/Items not in prompt delivery. Please contact the commercial department to check availability;

3 Articoli prodotti solo su richiesta /Items produced only on demand;

4 Fino ad esaurimento/Until exhaustion.

Pannelli wall/Wall panels

L 70 x H 57



P 60 x H 42,5

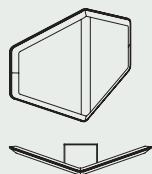

300.PC.03.01  
Concavo  
/Concave

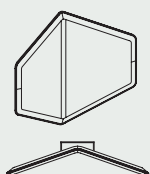

300.PC.04.01  
Convesso  
/Convex

Totem

L 60 - H 183

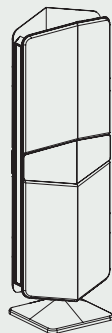

300.EM.01.00  
Totem con pannelli fonoassorbenti e sistema di illuminazione led RGB  
/ Totem with acoustic panels and led lighting system RGB

Pannello ceiling sospeso /Suspended ceiling panel

L 60 x H 60

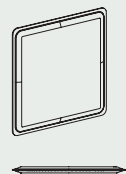

300.PC.05.01

Pannello ceiling per controsoffitto /Ceiling panel for suspended ceiling

L 60 x H 60

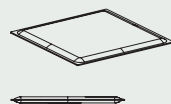

300.PC.06.01

Kit per ceiling /Kit for ceiling

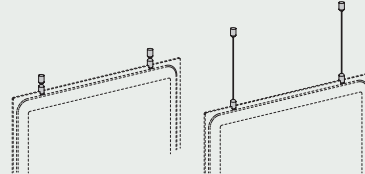

300.KT.05.00  
Variante per fissaggio a soffitto  
/Ceiling fixing variant

300.KT.05.00  
Variante per fissaggio a soffitto con cavi  
/Ceiling fixing variant with cables

Frontal panel speciali /Special frontal panels

P 2,8 H 59 x L 79,7

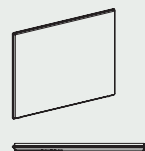

300.FR.10.08.21

P 2,8 H 60,8 x L 199,7

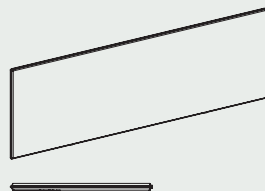

300.FP.60.20

P 2,8 H 30 x L 79,7



300.FR.10.08.11

P 2,8 H 42,5 x L 139,7

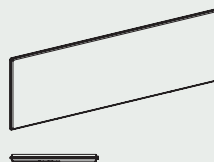

300.FP.60.40

P 3 x H 39

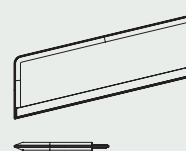

300.FP.45.06 L 64  
300.FP.45.07 L 79  
300.FP.45.09 L 99  
300.FP.45.11 L 119  
300.FP.45.13 L 139  
300.FP.45.15 L 159  
300.FP.45.17 L 179  
Frontal panel per profilo  
attrezzabile DV801 / Frontal  
panel for accessories profile  
DV801

P 3 x H 59

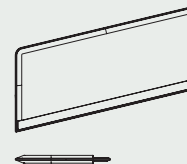

300.FP.55.13 L 139  
300.FP.55.15 L 159  
Frontal panel per profilo  
attrezzabile DV801 / Frontal  
panel for accessories profile  
DV801

Pannello ceiling speciale/Special ceiling panel

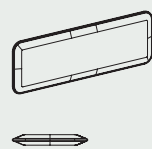

300.PC.07.01

Note:

1 Le dimensioni sono espresse in cm – consultare il listino prezzi per le caratteristiche tecniche, i codici degli articoli e delle finiture/Dimensions are stated in cm – for technical characteristics, article code numbers and finishing see price list;

Prodotti non in pronta consegna. Per la disponibilità contattare l'ufficio commerciale/Items not in prompt delivery. Please contact the commercial department to check availability;

Prodotti Colibri/Colibri products.